



Rescue Response
Kids Ride on Car
Installation and Operation Instructions



Please read this instruction manual carefully. It is important to read and follow all of the steps during assembly to ensure proper operation and safety of the child. Please keep this manual for future reference.



**Scan this QR Code
to view the
Assembly Video**

SPECIFICATIONS:

Battery Type:	12V10AH	Avg. Speed:	2 – 3 MPH
Age Range:	2 – 5 Years	Charging time:	8-12 hrs – Minimum 1 Charge per month
Max. Weight:	70 lbs	Avg. Use Time:	48 - 90 Minutes (depending on use)
Product Size:	49 x 27 x 25 inches	Remote Battery:	2 - AAA (not included)

IMPORTANT!

<ul style="list-style-type: none"> Assembly of car and charging of battery is only to be done by an adult.  	<ul style="list-style-type: none"> WARNING!! NOT TO BE USED ON STREETS or IN TRAFFIC.
<ul style="list-style-type: none"> Never modify the electric circuit system or tamper with electric system. This can cause permanent damage. 	<ul style="list-style-type: none"> Please check the product regularly for any loose parts or wires to ensure proper operation.
<ul style="list-style-type: none"> Adult supervision is recommended during operation by child to avoid injury. Safety equipment is recommended. 	<ul style="list-style-type: none"> Please make sure that the child uses caution to avoid falls and collisions, which could cause injury to the child or third party.
<ul style="list-style-type: none"> Do not pick up vehicle by steering wheel. 	<ul style="list-style-type: none"> Do not pick up battery by wires or charger.
<ul style="list-style-type: none"> Keep all plastic bags out of the reach of young children. 	<ul style="list-style-type: none"> Not recommended for children under the age of 2 yrs. due to small parts that could cause a choking hazard.
<ul style="list-style-type: none"> Battery must be charged for a minimum of 8-12 hours prior to first use of the car to avoid damage to the battery. Power switch must be in off position when charging. 	<ul style="list-style-type: none"> Battery charger should be examined for damage prior to each use. It is important to inspect the cord and both ends for damage. If damage is found, DO NOT USE THE CHARGER! Contact us for replacement charger.
<ul style="list-style-type: none"> Please retain instruction manual for future reference. 	<ul style="list-style-type: none"> Please retain packaging in the event it is necessary to return.



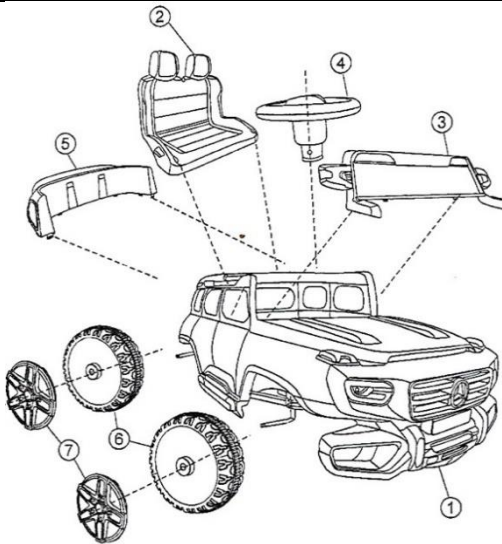

If the charger is plugged into the charging port, the car will not power up regardless if the charger is plugged into the wall outlet or not.

PARTS LIST

No.	Name of Part	Qty.	No.	Name of Part	Qty.
1	Main Body	1	5	Rear Wing	1
2	Seat	1	6	Driving Wheel	4
3	Wind Shield	1	7	Wheel cover	4
4	Steering Wheel	1	8		

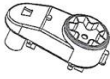

ADDITIONAL PARTS:

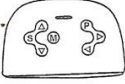
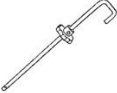
Gear Box		2	Parts Bag		1
Charger		1	Instruction Manual		1
emote Control		1	Steering Shaft		1

[All assembly videos can be found on YouTube under SPORTrax](#)

Assembly Instructions:

Front Tire Assembly:

Turn the car body upside down. Slide a washer onto each front axle. Next, slide a tire onto each axle followed by a washer, and lock nut. Tighten the lock nuts, with the wrench provided, until the end of axle is even with the outside of the lock nut. (Do not over tighten) Snap wheel cover into place by lining up the tabs on the wheel cover with the corresponding slots in the wheels.

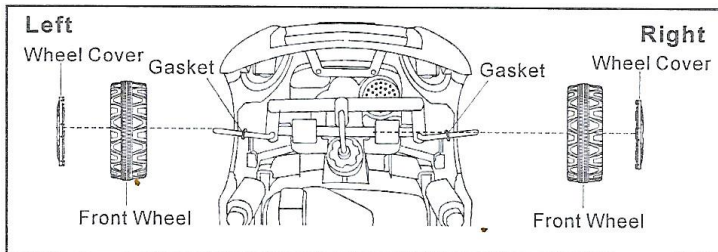

Back Tire Assembly:

Locate the 2 hub adaptors and screw the adaptors onto the back of the 2 remaining tires with supplied screws. (you will need 4 screws per tire) Once hub adaptors are installed onto the tires, slide tires onto the rear axle and align the hub adaptor with the gear box. Next, install a washer & lock nut and tighten down with wrench. Snap wheel cover into place by lining up the tabs on the wheel cover with the corresponding slots in the wheels.

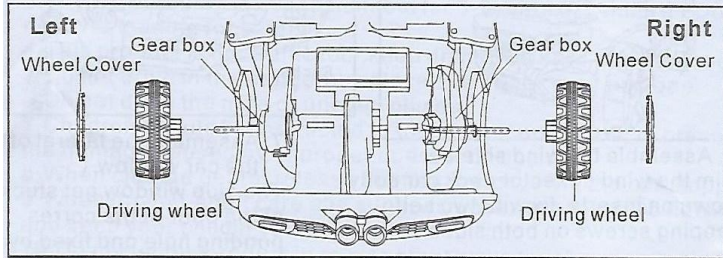

Installation of Steering Shaft:

Locate the steering shaft and guide it up into the steering motor. The hook at the end of the axis should hook into the eye hole on the front axle assembly. Ensure the steering rod is properly seated into steering motor on the bottom of the vehicle. Failure to do this step will result in the inability to secure the steering wheel to the vehicle.

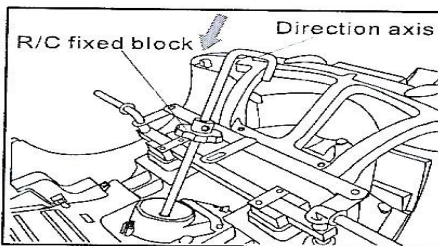

Steering Wheel Assembly:

Remove the nut and bolt from steering wheel. Connect the steering wheel wires and slide the steering wheel onto the steering shaft. Place bolt through the steering wheel column and replace nut to secure. The steering wheel should **never** be used to pick-up the vehicle.

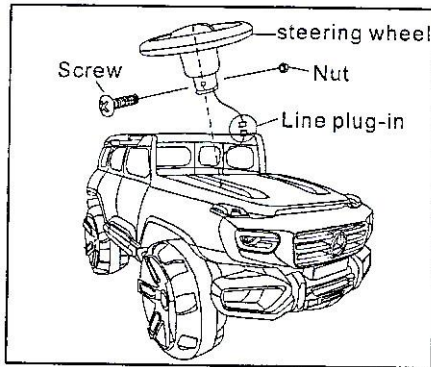

Seat Assembly:

Locate the seat of the vehicle. Make sure the seat belt is not covered by the seat. Install seat by sliding hooks into the body of the vehicle, and secure with 2 screws.

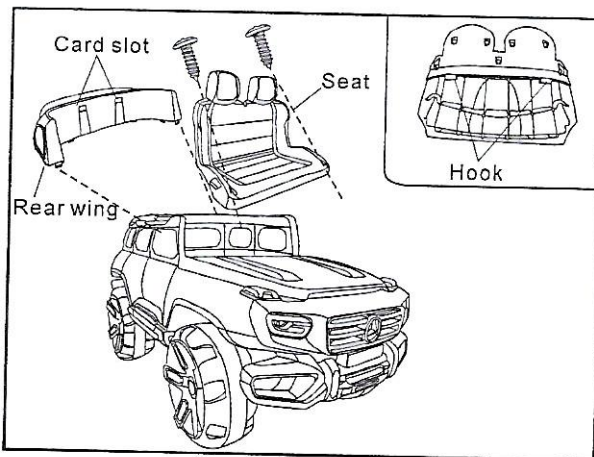

Power supply Connection:

Connect the power as shown in the diagram (most of the time this will already been done for you). The red wire should be connected into the red port, and the black wire going to the black port.

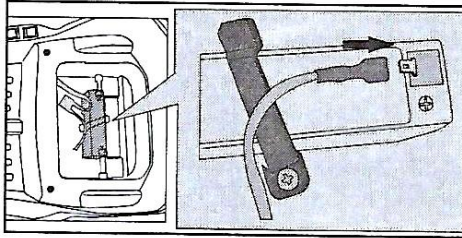

Charging:

The charging port is located under the seat of the vehicle. Plug the charger into the charging port first, then plug the charger into a wall outlet.

Please Note: As a safety precaution and to avoid damage to the charger, the car will not power up while charger is plugged into the charging port of the car.

BATTERY MUST BE CHARGED FOR A MINIMUM OF 8-12 HOURS BEFORE INITIAL USE TO AVOID DAMAGE TO THE BATTERY. ONLY AN ADULT SHOULD CHARGE AND RECHARGE THE BATTERY!

BATTERY REPLACEMENT AND DISPOSAL:

The battery will eventually lose the ability to hold a charge. Depending on the amount of use, and varying conditions, the battery should operate for one to three years. Follow these steps to replace and/or dispose of the battery:

- Disconnect the battery connectors
 - Remove the battery bracket
 - Carefully lift the battery - you may want to wear protective gloves before removal - **Do Not** lift the battery by its connectors or cables
 - Place the dead battery in a plastic bag
 - Replace the battery and reconnect the connectors
- Reinstall the battery bracket

Please give us a call for your battery replacement needs or visit our website to place an order.

Fuse:

This vehicle comes with a self-setting fuse. If the vehicle stops unexpectedly it will mainly be from a current that exceeded the fuse's specified allotment of current. When this happens wait 8 seconds and then the fuse will automatically restart.

To avoid tripping the fuse:

Do not overload weight limit, stay within the weight recommendations.

Do not pull anything with the vehicle.

Do not let water or any other liquids touch circuits, battery, or other parts.

Do not modify the structure or electric circuit system of this vehicle.

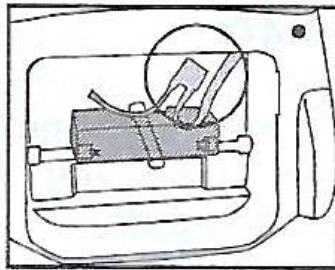

Remote Control Instructions:

Operating the remote control

1. Install batteries

2. Hold **M** button for more than three seconds until light flashes

Then turn on the car, light should go solid and will be paired to the car.

1 Light=Slow Speed

2 Lights=Medium Speed

3 Lights=High Speed

P=Parking brake



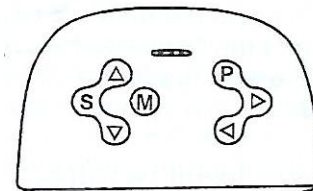











S=Speed Control



M=Code Matching

Power Button Panel



	HIGH SPEED		FORWARD & VOLUMN UP		AUX PORT
	LOW SPEED		PLAY & PAUSE		MICRO SD PORT
	HEAD & TAIL LIGHTS		PREVIOUS & VOLUMN DOWN		BATTERY VOLTAGE DISPLAY
	STORYTIME		PRE-LOADED MUSIC		IPOD/USB PORT
	EDUCATION		RESCUE MODE		

WARNING:

- Use only the rechargeable battery and charger supplied with your vehicle. **NEVER** substitute the battery or charger with another brand. Using another battery or charger may cause damage.
- **NEVER** modify the electric circuit system. Tampering with the electric system may cause permanent damage to the system.
- **Do not** allow direct contact between battery terminals.
- **Do not** allow any type of liquid on the battery or its components.
- Charge the battery in a well-ventilated area **ONLY**. Do not charge near or around flammable materials.
- **NEVER** pick up the battery by the wires or charger. Damage can occur to the battery and may cause a fire. Pick up the battery by the case **ONLY**.
- Charge the battery in a dry area **ONLY**.

Wash hands after handling.

- **Do not** open the battery. Battery contains lead acid and other materials that are toxic and corrosive.
- **Do not** open the charger. Exposed wiring and circuitry inside case could cause electric shock. **NEVER** allow a child to handle or charge the battery. Battery is heavy and contains lead acid (electrolyte).
- **Do not** drop the battery. Permanent damage to the battery could occur or cause serious injury.
- Before charging the battery, check for wear or damage to the battery, charger, its supply cord and the connectors. **DO NOT** charge the battery if any damage to parts has occurred.
- **Do not** allow the battery to drain completely. Recharge the battery after each use or once per month if not used regularly.
- **Do not** charge the battery upside down.
- **Always** secure the battery with the bracket. Battery can fall out and injure a child if vehicle tips over.
- The **Power Switch** must be turned in the **OFF** position when charging.
- When the car begins to run slowly, recharge the battery.

GENERAL MAINTENANCE:

It is the parent's responsibility to check main parts of the toy before using. Regularly examine the car for potential hazard, such as damage to the battery, charger, cable or cord, and plug. Also, check that all screws are tightened throughout the car. In the event of such damage, the toy must not be used until that damage is repaired or replaced.

- Make sure the plastic parts of the vehicle are not cracked or broken.
- Occasionally use a lightweight oil to lubricate moving parts such as wheels.
- Park the vehicle indoors or cover it with a tarp to protect it from wet weather.
- Keep the vehicle away from sources of heat, such as stoves and heaters. Plastic parts may melt.
- Recharge the battery after each use. Only an adult should handle the battery. Recharge the battery at least once a month when not being used.
- Do not wash the vehicle with a hose. Do not wash the vehicle with soap and water. Do not drive the vehicle in rainy or snowy weather as water will damage the motor, electric system and battery.
- Clean the vehicle with a soft, dry cloth. To restore shine to plastic parts, use a non-wax furniture polish. Do not use car wax. Do not use abrasive cleaners.
- Do not drive the vehicle in loose dirt, sand or fine gravel which could damage moving parts, motors or the electric system.
- For extended times when the car will not be used, the power switch needs to be in the off position and the electrical connections should be disconnected from the battery.

TROUBLE SHOOTING GUIDE:

Problem	Possible Cause	Possible Solutions
Car will not move	<ol style="list-style-type: none"> 1. Battery voltage is low. 2. Battery connector or wires are loose. 3. Battery is damaged or dead. 4. Electrical box or motor is damaged 	Charge the battery Re-connect the battery connector to the car Replace battery Replace motor
The battery will not charge.	<ol style="list-style-type: none"> 1. Battery connector may have come apart or have a bad connection. 2. Battery charger plugged into a bad wall outlet. 3. Battery charger is damaged. 	Re-connect the battery connector to the car electrical connector Try another wall outlet Replace battery charger
Shortened battery life	Battery was not charged fully Battery is old	Charge battery fully Change battery
Some Noise and heat when charging battery	Chemical reaction	Normal
Low Speed	Battery is old Battery is low on charge Weight limit exceeded Uneven or uphill path Vehicle is being used in harsh conditions	Change the battery Charge the battery Do not exceed max weight limit Use on flat surfaces Avoid using car in harsh conditions
Noise coming from motor/gearbox	Gear in motor/gearbox broken	Call for replacement motor
The car shakes when moving	Bad Connection of the motor wires Possible motor failure	Reconnect wires Call for replacement motor
Car needs a push to go forward	Poor contact of wires and/or connectors "Dead Spot" on motor	Check that the battery connectors are firmly plugged into each other. If wires are loose around the motor, contact the distributor's service department A dead spot means the electric power is not being delivered to the terminal connection. Call our service department

Self-Resetting Breaker – The vehicle is equipped with a self-resetting breaker. In the event the power is tripped the breaker will reset itself in approximately one minute.

If you are unable to solve a problem, please feel free to contact us.

Phone: 402-477-0541 or Email: customerservice@rollinghillstrading.com